

Vernis Blend

Single lever basin mixer 70 with isolated water conduction and pop-up waste set

Surfaces: **Chrome** Article Number: **71570000**



Description

product features

- consists of: single lever basin mixer, waste set
- ComfortZone 70
- projection 89 mm
- spray type: normal spray
- swiveling spray former
- maximum flow rate at 3 bar: 5 l/min
- ceramic cartridge
- temperature limitation adjustable
- with isolated water conduction - without contact with nickel and lead
- suitable for continuous flow water heaters
- pop-up waste set G 1¼
- material waste set: synthetic
- connection type: G ¾ connections
- connection dimension: DN15

Technology



Product image



Scale drawing

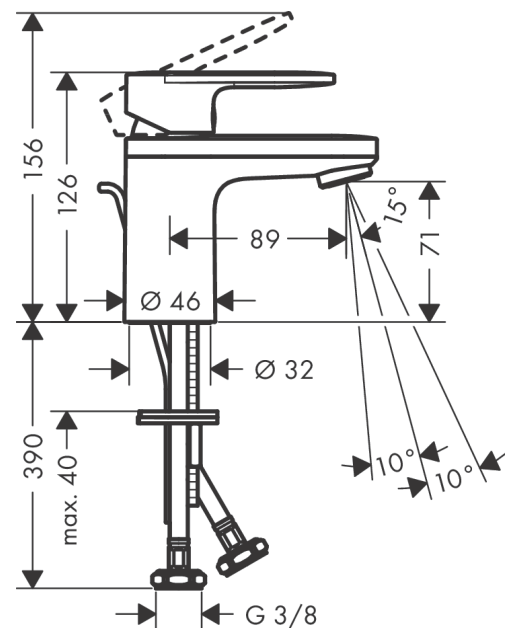

Vernis Blend

Single lever basin mixer 70 with isolated water conduction and pop-up waste set

Surfaces: **Chrome** Article Number: **71570000**



Flowchart



Vernis Blend

Single lever basin mixer 70 with isolated water conduction and pop-up waste set

Surfaces: **Chrome** Article Number: **71570000**



Exploded Drawing

Year of production: >04/21

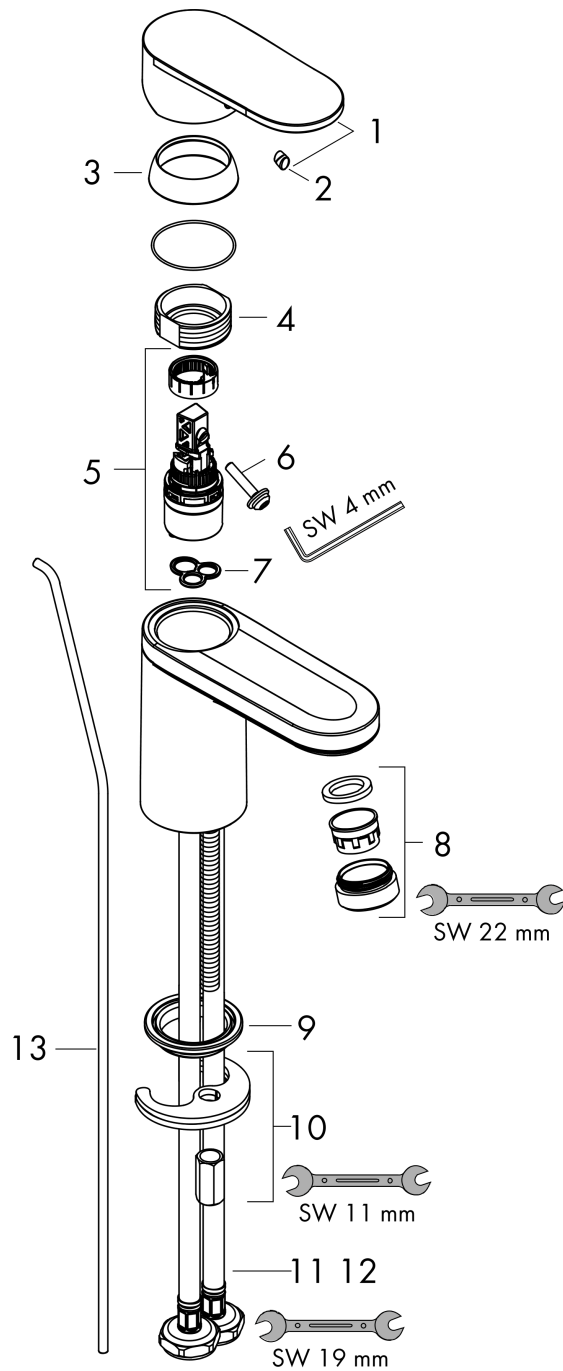

Vernis Blend

Single lever basin mixer 70 with isolated water conduction and pop-up waste set

Surfaces: **Chrome** Article Number: **71570000**



Spare part list

Year of production: >04/21

Pos.	Description	Article Number	Price	PU
1	handle	93678000	-	1
2	screw cover	96338000	-	1
3	flange	93680000	-	1
4	nut	93686000	-	1
5	cartridge, assy	97685000	-	1
6	locking screw for handle	95140000	-	1
7	seal	98865000	-	1
8	aerator swivelling M24x1 (5 l/min)	93834000	-	1
9	seal Ø 42	98722000	-	1
10	fixing set	96016000	-	1
11	connection hose 450 mm M8x0,75 G3/8	97206000	-	1
12	O-ring 7x1,5	98422000	-	1
13	pull rod	93683000	-	1
a	pop up waste	92168000	-	1
b	lever arm 340mm (ball-Ø12mm)	96324000	-	1